

### KEY FEATURES

- Designed for compression drivers with 1.4" throat diameter
- It provides uniform response, on and off-axis with a neutral and natural frequency reproduction
- Coverage angles of 60° in the horizontal plane and 50° in the vertical plane
- Precise directivity control in the pass band
- Its square form provides more versatility to mount it in the box



### GENERAL DESCRIPTION

This 1.4" entry horn is designed to provide uniform on and off-axis response. The constant directivity characteristics of this model ensure the ability to cover 60° wide horizontally and 50° wide vertically, at virtually any frequency within its operational range. To ensure freedom of resonance, this flare is constructed of cast aluminium, with flat front finish for an easy flush mounting.

### TECHNICAL SPECIFICATIONS

<b>Throat diameter</b>	36 mm. 1.4 in.
<b>Horizontal beamwidth</b>	60° (+27°, -6°) (-6 dB, 1 - 16 kHz)
<b>Vertical beamwidth</b>	50° (+20°, -1°) (-6 dB, 2.5 - 16 kHz)
<b>Directivity factor (Q)</b>	11.1 (average 0.63 - 16 kHz)
<b>Directivity index (DI)</b>	10.3 dB (+1.9 dB, -2.4 dB)
<b>Cutoff frequency</b>	800 Hz
<b>Dimensions (WxHxD)</b>	235x235x120 mm. 9.25x9.25x4.72 in.
<b>Cutout dimensions (WxH)</b>	204x202 mm. 8.03x7.95 in.
<b>Net weight</b>	1.2 kg. 2.64 lb.
<b>Shipping weight</b>	1.53 kg. 3.37 lb.
<b>Construction:</b>	Cast aluminium.
Connection of driver by four screws on a 101.6 mm. diameter bolt circle.	

### DIMENSION DRAWINGS

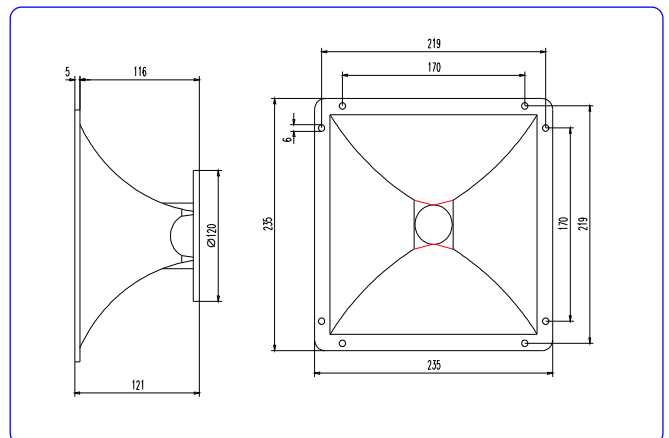

### -6 dB BEAMWIDTH \*

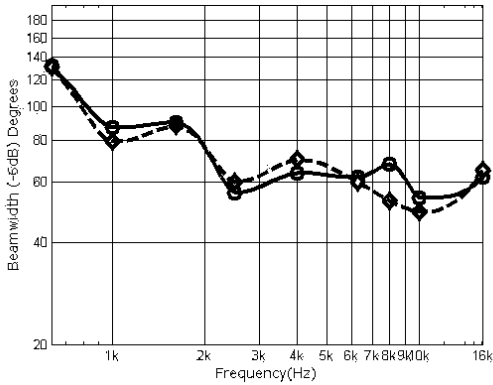

### DIRECTIVITY

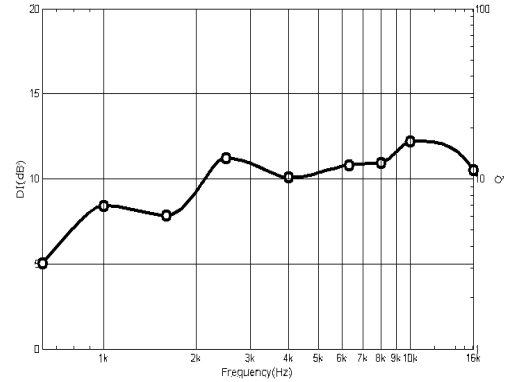

### POLAR RESPONSE \*\*

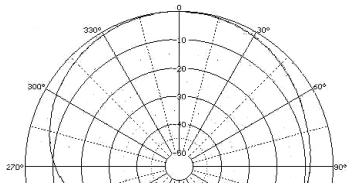

630 Hz

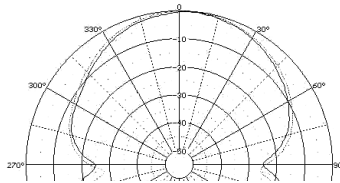

1 kHz

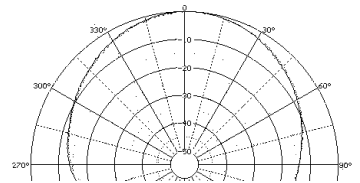

1,6 kHz

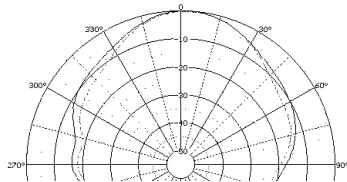

2,5 kHz

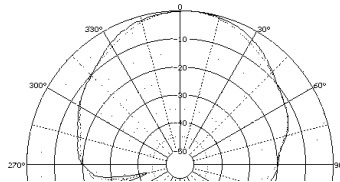

4 kHz

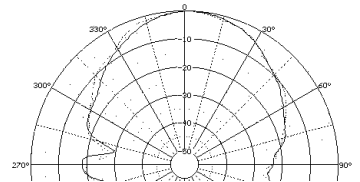

6,3 kHz

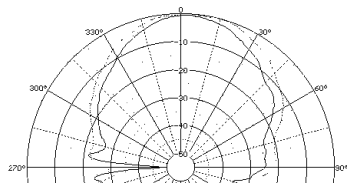

8 kHz

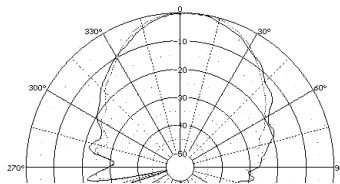

10 kHz

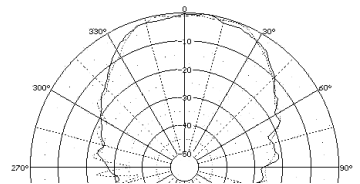

16 kHz

**Notes:**

\*Horizontal beamwidth is represented by the heavy line.  
Vertical beamwidth is represented by the discontinuous line.

\*\* Horizontal response is represented by the heavy line. Vertical response is represented by the discontinuous line.  
The polar plots are reproduction of measurements done with single sinusoidal signal tones, at the indicated frequencies.  
The microphone was placed 2m. from the horn, and rotation was about the centre of the emitter source.